

# bookcases/wall units

---

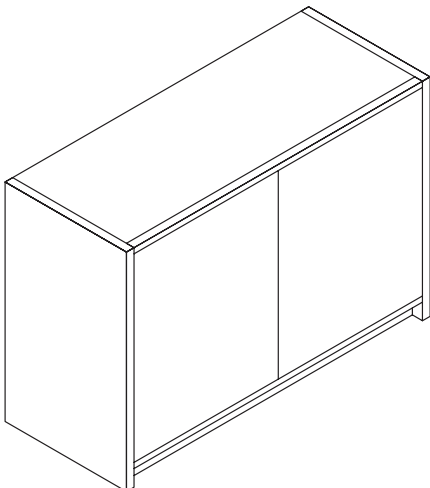
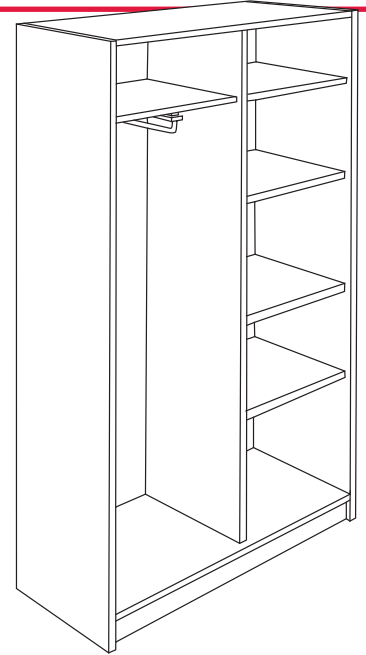
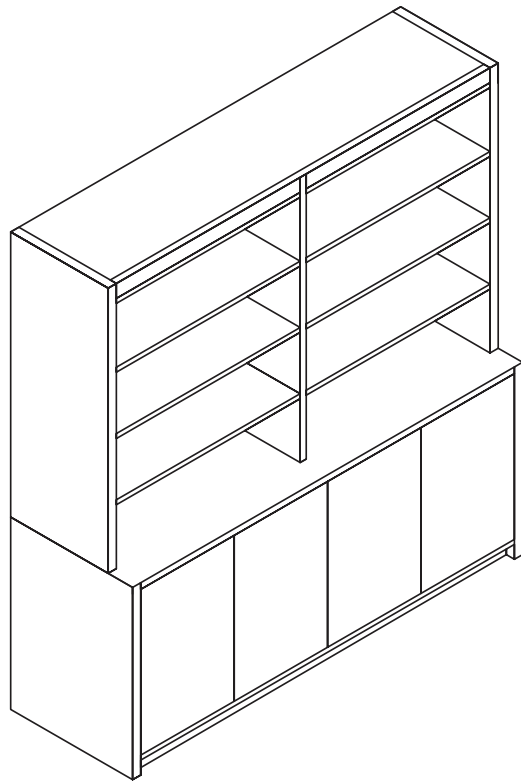

**arnoldkolax**

Arnold Kolax Furniture, Inc.

- Information for Ordering .....2
- Product Information.....3 – 4
- Condition of Sale .....4 – 5
- Furniture Quote Information .....6
- Notes.....7
- Bookcases / Wall Units Overview.....8 – 9
- Combining Bookcase Units .....10
- How to Specify.....11

**Wall Unit Typical** .....12 – 14

**Bookcase Units**

- Open Bookcase Vertical Units.....15
- Special Width Open Bookcases .....16
- Bookcases with Sliding Doors .....16
- Bookcases with Full Wood Doors .....17
- Open Bookcases with Bottom Doors.....18 – 19
- Open Bookcases with Bottom Lateral File Drawers .....20
- Video Cabinets .....21
- Corner Units .....22
- Overhead Cabinets & Runoffs.....23
- Component Cabinets: Pedestals, Bars & Refrigerator .....24
- Cornice Tops, Mullions and Panels .....25
- Shelves and Worksurfaces.....26
- Bookcase Accessories: Glass & Wood Doors .....27
- Wall-Hung Shelves .....28 – 29

**Options** .....30

**Dock Delivery Price List** .....31

**Literature Request Form** .....32

# arnoldkolax

Arnold Kolax Furniture, Inc.

**Manufacturer:** Arnold Kolax Furniture, Inc. • 609 Chancellor Avenue, Irvington, NJ 07111  
 Tel 973-375-3344 • Fax 973-375-6024 • Toll Free 866-425-6529  
 www.arnoldkolax.com • info@arnoldkolax.com

## General Information for Ordering:

---

1. **Point of Production:** Irvington, NJ (Essex County)
2. **Time of Delivery:** Approximately 8 weeks
3. **Expedited Delivery:** Some items in this catalog are available for expedited delivery. Call factory for information.
4. **Overnight and 2-day Delivery:** Not available.
5. **F.O.B. Point:** Irvington, New Jersey, Essex County
6. **Ordering Address:** Arnold Kolax Furniture, Inc., 609 Chancellor Avenue, Irvington, New Jersey 07111
7. **Payment Address:** Arnold Kolax Furniture, Inc., 609 Chancellor Avenue, Irvington, New Jersey 07111
8. **Terms and Conditions of Rental, Maintenance and Repair:** Call Factory
9. **Terms and Conditions of Installation:** Call Factory
10. **Terms and Conditions of Repair Parts:** Call Factory
11. **Service and Distribution Points:** Contact your local Arnold Kolax Furniture, Inc. representative for current listing of service and distribution points.
12. **List of Participating Dealers:** Contact your local Arnold Kolax Furniture, Inc. representative for current listing of authorized dealers in your area.
13. **Preventative Maintenance:** Contact factory for pamphlet.

## Product Information:

---

- 1. Woods/Veneers:** All solid woods and veneers used on exterior surfaces are #A select grades. Plain sliced *American Walnut*, *White Oak*, *Maple*, and *Cherry*, applied in a “reverse slip match” fashion resulting in a balanced appearance, as well as slip match *Sapele* (Mahogany), are the standard veneers used. Anigre veneers are available at an upcharge. Every effort is made to match solid wood and veneer of like color and grain, however, since wood is a natural material, some variation in grain, color, and character may occur. This variation is not considered a defect.

Arnold wood sample color chips are dated, and only chips dated with the current year should be used. If older samples are used, please send the sample used with the purchase order for proper color adjustment.
- 2. About Woods:** Arnold Kolax Furniture would like to take this opportunity to point out to its customers several of the distinguishing characteristics that make wood such a unique material with beauty and charm:

  - No two trees are exactly alike, and as a result, natural variations in color and tone are to be expected.
  - Solid woods and veneers accept stain in varying degrees, thereby contributing to slight differences in shading.
  - Woods are highly susceptible to color changes from exposure to light, particularly from the ultraviolet rays. Cherry is extremely photo sensitive. It is recommended that the end user be instructed to avoid placing wood products in areas with prolonged exposure to direct sunlight. This will help to minimize, though not eliminate, color changes.
  - Properly maintained levels of humidity in the environment where the furniture is placed should also minimize instances of warping, checking, and cracking of veneers and solids. Fluctuations in humidity and temperature may cause panels and solid wood components to expand and contract, and may lead to panel warpage and finish checking or cracking. Prolonged exposure of furniture to dry heat during winter months should be avoided.

A minimum humidity level of 45% in climate controlled buildings is very important for the proper care of natural wood products.

**Note:** Due to the nature of Burl and Crotch veneers, the temperature and humidity of the environment into which the product is placed may cause changes to the face veneer. Arnold cannot be held responsible for checking and/or shrinkage that may occur over the course of time.
- 3. Wood Finishes:** Arnold Kolax Furniture offers a substantial number of different stains on *White Oak*, *Walnut*, *Sapele* (Mahogany), *Cherry*, *Anigre* and *White Maple* solid woods and veneers. A “seven step” open pore finish is standard. It is a rich, lustrous, water and alcohol resistant, 40° satin sheen, multi-coat pre-catalized top coating applied over a “hand rubbed” wiping stain. Color consistency is maintained by constant comparisons to “control panels” at every step in the finishing process.
- 4. Special Wood Finishes:** Arnold Kolax Furniture, Inc. provides its customers finish matching capability. Customer must submit a 3" x 3" sample of the finish to be matched.

The amount of upcharge is based on the following criteria:

  - \$82.50 minimum on any special wood finish.
  - Color matching only of samples with open or closed pore finish: +15%
  - Color and texture match of closed pore finishes: + 25%
  - Closed pore finish (top surface only) on any Arnold standard wood stain: + 10%
  - Buffed/polished appearance: call factory.
  - Finish matching requiring bleaching will result in an additional charge. The factory reserves the right to make the final determination.
- 5. Plastic Laminates:** Arnold Kolax Furniture offers both complete plastic laminate products and wood products with plastic laminate tops. In addition to the above, most products offered by Arnold Kolax Furniture are also available with laminate tops, at no additional charge, in any color or texture of your choice from Plonite, Nevamar, Formica, or Wilsonart.
- 6. Natural Stones:** Marble and granite tops are available on selected Arnold Kolax Furniture products. They can be either inlaid or overlaid (no wood edge). Please refer to the individual product sections to determine which products are available with stone tops.

Please note that not all granites are available on any given product; consult the introductory pages at the beginning of each section for availability.

**Product Information (cont'd.):**

**7. Finishes:**

**Wood Finish\***

*Wood is a natural material and some variation in color grain and character may occur. This variation is not considered a defect.*

<b>Walnut:</b>	#101 Royal Walnut	#105 Cappuccino Walnut
	#102 Cordovan Walnut	#106 Natural Walnut
	#104 Senator Walnut	#503 Ebonized Walnut
<b>Oak:</b>	#200 Natural Oak	#501 Ebonized Oak
	#201 Harvest Oak	
<b>Mahogany:</b>	#300 Mahogany	#303 Scarlet Mahogany
	#301 Cherry Mahogany	
<b>Cherry:</b>	#400 Medium Cherry	#404 Red Cherry
	#401 Light Cherry	#406 Classic Cherry
	#402 Victorian Cherry	#408 English Cherry
<b>Maple:</b>	#700 Natural White Maple	
	#701 Pearwood on Maple	
<b>Anigre:</b>	#603 Light Anigre (available at an upcharge)	
<b>Solid Color:</b>	#900 White	#904 Earth
	#901 Black	#905 Tangerine
	#902 Graphite	#906 Lime
	#903 Smoke Gray	#907 Misty Gray

**Natural Stone\*\*\***

*Marble and granite are natural materials and so some variations in pattern and color will exist within each slab, as well as from piece to piece.*

<b>Marble:</b>	<b>Granite:</b>
White Calacatta Gold (White)	Dakota Mahogany (Red/Black)
Jerusalem Gold Limestone (Gold)	Ubatuba (Gold/Black)
Light Emperador (Lt. Brown)	Blue Pearl (Black/Gray)
Verde Oriental (Green)	Impala Black (Black/Gray)
Rosso Levanto (Red)	Black Galaxy (Black)
Dark Emperador (Dk. Brown)	Absolute Black (Black)
Botticino Semi-Classico (Beige)	Luna Pearl (Salt/Pepper)
White Carrara (White)	Rosa Porrina (Rose/Gray)
Crystal Salome (Gray/Burgundy)	
Negro Marquina (Black)	
Rosa Aurora (Rose/White)	
Spring Green (Green)	

Please call factory for custom finish and/or stone availability. Available on coffee and end tables only.

When placing orders for products made by two or more Arnold Companies that are to be used in the same area, please indicate "finish together" on your purchase order, and verify our acknowledgement of this requirement.

- 8. **Special and Custom Items:** Arnold Kolax Furniture has the ability, through its flexible manufacturing policy, to produce custom library furniture, or modify any existing Arnold line to meet the user's requirements. Please submit your plans and specifications for a quotation. All sales on custom or specially modified items are final. A 50% deposit is required when the order is placed, whether or not credit is established with Arnold. These orders cannot be cancelled once the manufacturing process has started.
- 9. **Options/ Accessories:** A variety of product options are available from Arnold Kolax Furniture including such value added items as refrigerators, computer support peripherals and a variety of Power, Data, and Voice grommets that allow the user to connect and conceal CRT and CPU hardware. The compatibility of individual options is noted on each page; a more detailed description of the option is at the back of the book.
- 10. **GSA** Arnold Kolax Furniture has been awarded several GSA (Government Services Administration) federal and state contracts. GSA price listed and state contract details and procedures are available on request and at our website.

**Condition of Sale:**

- 1. **Terms:** Net 30 days. All prices shown in this price list are list prices, FOB our factory Irvington, New Jersey. Prices are effective January 1, 2007 and are valid until superceded. This price list supercedes all previous Arnold Kolax Furniture price lists.  
**Ordering Information** — Order directly by mail, fax, telephone or email to Arnold Kolax Furniture as indicated on page 2 in this price list. Orders for merchandise from more than one Arnold Company may be sent to any one of the companies. Telephone orders must be confirmed by a purchase order. Duplicate orders received not marked "Confirmation" are the responsibility of the buyer.
- 2. **New Accounts:** Please include three satisfactory credit references, one bank reference, and a 50% deposit with your first order.
- 3. **Acknowledgements:** Upon credit approval, all orders will be acknowledged by Arnold Kolax Furniture. Acknowledgements indicate terms of sale, discount rate, buyer's representative, transportation company, approximate shipping date, merchandise ordered, freight cost if applicable, and our acknowledgement number. All prices are FOB factory, blanket wrapped, unless otherwise indicated. Please check the acknowledgement for accuracy, and call Arnold Kolax Furniture immediately in case of a question or discrepancy. Arnold Kolax Furniture will not be held responsible on orders placed on the phone without written confirmation.

## Condition of Sale (cont'd.):

---

4. **Prices:** Prices are based on an order as written, and not necessarily on your inquiry or our original quotation. The prices as shown on the acknowledgment are final and will be invoiced on the date of shipment.
5. **Cancellation and/or Changes:** Orders are processed immediately upon receipt, and cancellations or changes can only be made with prior approval of Arnold Kolax Furniture. A cancellation charge of 10% will be incurred after a period of three working days. Cancellation of "Work in Progress" is subject to a 25% charge. Special orders, special finishes, "Quick Ship," and orders marked "Rush" cannot be cancelled. Cancellation of a standard unit after fabrication will incur a 50% charge.
6. **Shipping Delays:** Diligent effort will be made to ship orders for the date acknowledged. We cannot be held financially responsible for delays due to strikes, accidents, raw material shortages or other delays.
7. **Packing & Shipping:** Goods are carefully inspected and blanket wrapped or cartoned before being turned over to the transportation company.
8. **Damaged Material:** The goods are carefully inspected and in good condition when accepted by the carrier. If damage occurs, it is your responsibility to immediately notify the transportation company to make an inspection prior to discarding packaging material. If the packaging material is damaged, you must make this request upon receipt of the shipment. If the damage is concealed, you must make this request when the material is unpacked and save the packing materials.
9. **Manufacturing Defects:** Claims of a factory defect must be verified by a factory representative. Unauthorized deductions from our invoice will not be allowed.
10. **Generalities:** All Arnold Kolax Furniture products (if applicable) are shipped with heavy duty 1/4-20 tread adjustable nylon glides that permit perfect drawer and door alignment. A strip of wood (a skid strip) protecting the product during shipment must be removed before the glides can be adjusted to meet the contours of the floor. Multi-piece table tops are shipped with "level tights," that allow for perfectly flush alignment of tops.
11. **Product Changes:** Arnold Kolax Furniture reserves the right to make changes in design and construction or to discontinue products without prior notice.
12. **Warranty:**

Arnold Kolax Furniture warrants to its initial customers that its products conform to specifications, drawings, samples, or other product descriptions furnished by Arnold Kolax Furniture, and are of good material and workmanship, free of manufacturing and factory defects, and will function properly under normal use and service for three years if installed by Arnold Kolax Furniture or an authorized Arnold dealer. However, natural variations in color and grain patterns occur in bent wood, solid wood, and veneers.

The warranty set forth above does not apply to products modified, altered, or repaired by unauthorized personnel, or to products damaged during shipment or installation, or by accident, abuse, alteration, misuse, tampering, misapplication, negligence by others, improper repair or maintenance, fire and/or other casualty. This warranty does not apply to defects in components not manufactured by Arnold Kolax Furniture.

It is expressly understood and agreed that the customer's sole and exclusive remedy for any and all losses or damages resulting from non-conforming goods, or from any other causes, shall be the repair or replacement of defective parts at the option of Arnold Kolax Furniture, and that Arnold Kolax Furniture shall not be liable for damages, for injury to persons or property, nor for replacement of the entire commercial unit, if repair or replacement of defective parts can reasonably render the unit conforming.

SELLER MAKES NO OTHER WARRANTIES, EITHER EXPRESSED OR IMPLIED, AS TO ANY MATTER WHATSOEVER, AND ARNOLD KOLAX FURNITURE DISCLAIMS ANY WARRANTY OF MERCHANTABILITY OR FITNESS FOR A PARTICULAR USE OR PURPOSE.

No officer, employee, or representative of Arnold Kolax Furniture has the authority to assume greater liability than that described above.

# Furniture Quote Information

Date: \_\_\_\_\_

When requesting a furniture quote, please provide Arnold Kolax Furniture the following information:

## General Information

- Customer Name \_\_\_\_\_
- Customer Location \_\_\_\_\_
- Customer Phone/Fax/Email \_\_\_\_\_
- Project Name/Location \_\_\_\_\_

## Freight Information

- Freight Address \_\_\_\_\_
- Dock Delivery/Inside Delivery (Freight Elevator) \_\_\_\_\_

## Product Information

- Furniture Info \_\_\_\_\_
- Style # \_\_\_\_\_
- Color Finish \_\_\_\_\_
- Edge Detail \_\_\_\_\_
- Special Dimension Requirements \_\_\_\_\_
- Special Instructions \_\_\_\_\_

### Example:

**Customer Name:** John Smith / Smith Interiors

**Customer Location:** 123 Main St., Anywhere, NY 10000

**Phone/Fax/Email:** (p) 555-555-1234 (f) 555-555-9876

**Project Name/Location:** Sunshine Office, Manhattan, New York

**Freight Address:** Shipping to Farmingdale, NY 11735 Inside Delivery (Freight Elevator)

**Furniture Info:** Open Bookcase with Sliding Glass Doors 30" W x 12" D x 42" H

**Style #:** GGD-4230

**Color Finish:** Standard Mahogany #300

**Edge Detail:** Universal Edge

**Hardware Specs:** Black Crescent Pulls / Black Locks

For assistance in preparing your quote request, please contact the office @ 973.375.3344



# Bookcases/Wall Units Overview

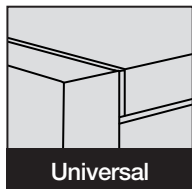

## Arnold Kolax Bookcases

Arnold Kolax bookcases are available in several designs. The edge details for bookcases and wall units are illustrated here.

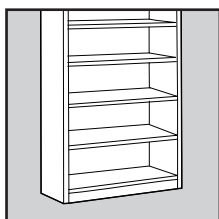

Open Bookcases

Page 15-16

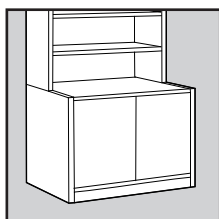

Bookcases with Doors

Page 17-19

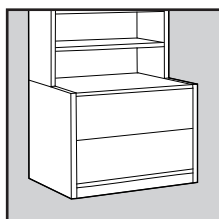

Bookcases with File Drawers

Page 20

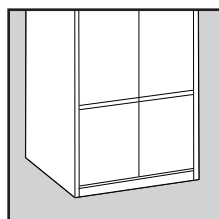

Video Cabinets

Page 21

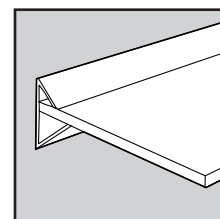

Wall-Hung Shelves

Page 28-29

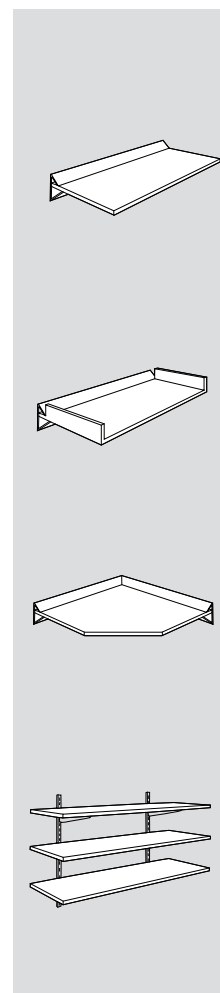
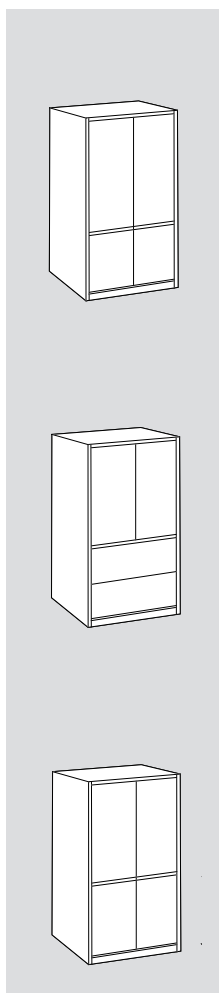
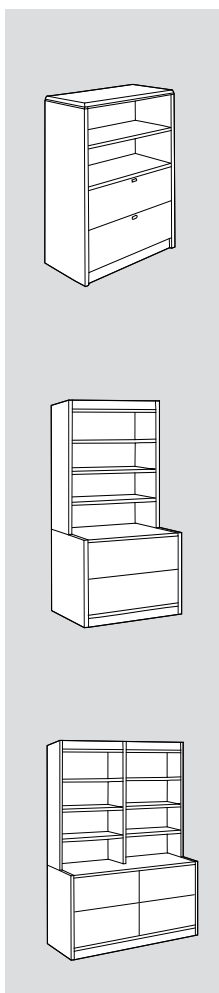
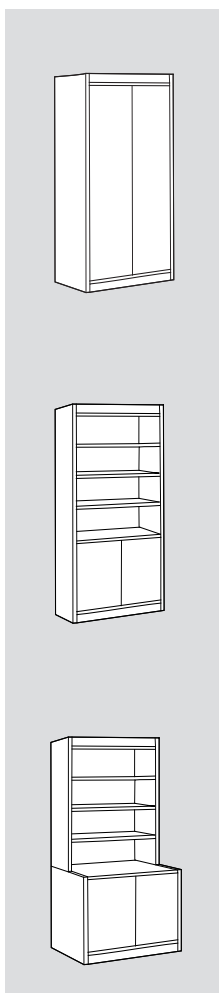
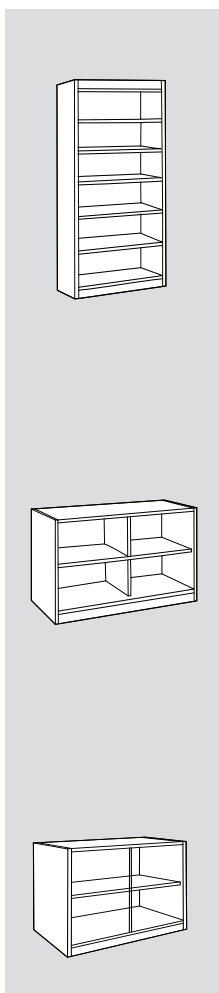

Arnold Kolax Bookcases are manufactured from veneer faced .75", 1", or 1.25" particle board with veneer banding or solid wood edges—see specifications at bottom of each page for particulars. Units have inside finished backs only; outside finished backs are available as an option at an upcharge. Bases are 3" high. Units 72" high and lower do not have top apron. Bookcases with doors are equipped with leveler glides for perfect adjustment and alignment.

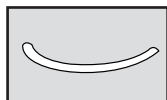

Brushed nickel pulls are standard, unless polished brass or black is specified.

**Shelves.** All shelves are 1" thick. For law offices or heavy duty use on 30" and 36" wide units, we recommend the 1.25" thick shelves, or units shown in our Library Price Guide.

**Cornices,** 2" high, are available in a variety of edges with and without lights. See page 25.

**Feature strips,** .5" wide in black laminate or standard wood finishes, are highly recommended between units with doors.

**Mullions,** 2" wide, are designed to be a decorative divider between bookcases, creating a more complete and formal appearance. See page 25.

All units are shipped set up.

**Custom configurations** of all Bookcases and CRT Series are available. Submit a drawing with dimensions and special requirements to Arnold Kolax or to your sales representative, for a quotation.

# Combining Bookcase Units

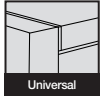

All of the individual bookcase models shown on the following pages can be combined to create a custom bookcase configuration tailored to your individual needs.

**It is recommended that you use featurestrips with the Universal series.** Ganging strips serve as 1/2" spacers between the units. If you wish to hide the multiplicity of uprights, you may choose to cover them with decorative mullions and end panels with facias.

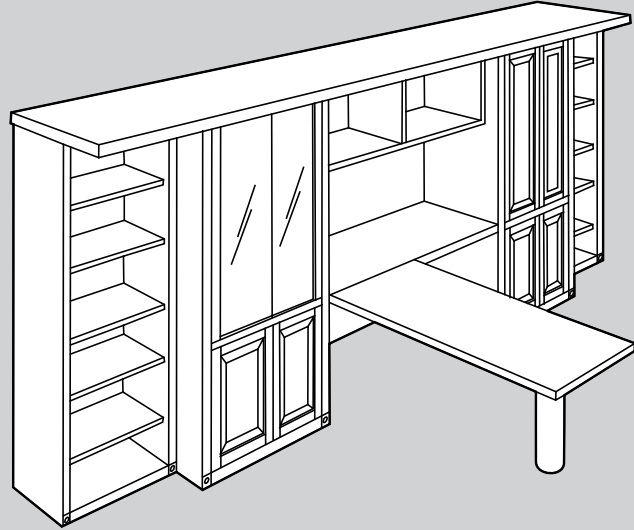

*The drawings on the right illustrate typical examples, but are intended as a guide only. Individual components should be selected to meet your needs and dimensions.*

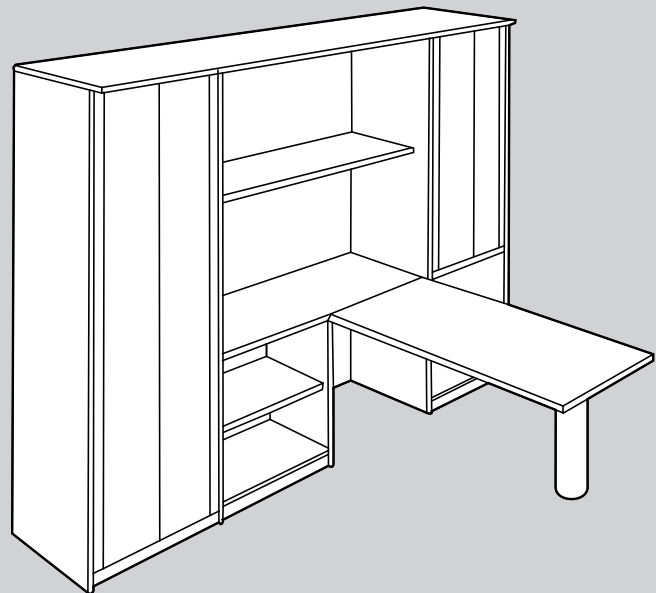

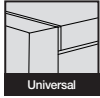

# How to Specify

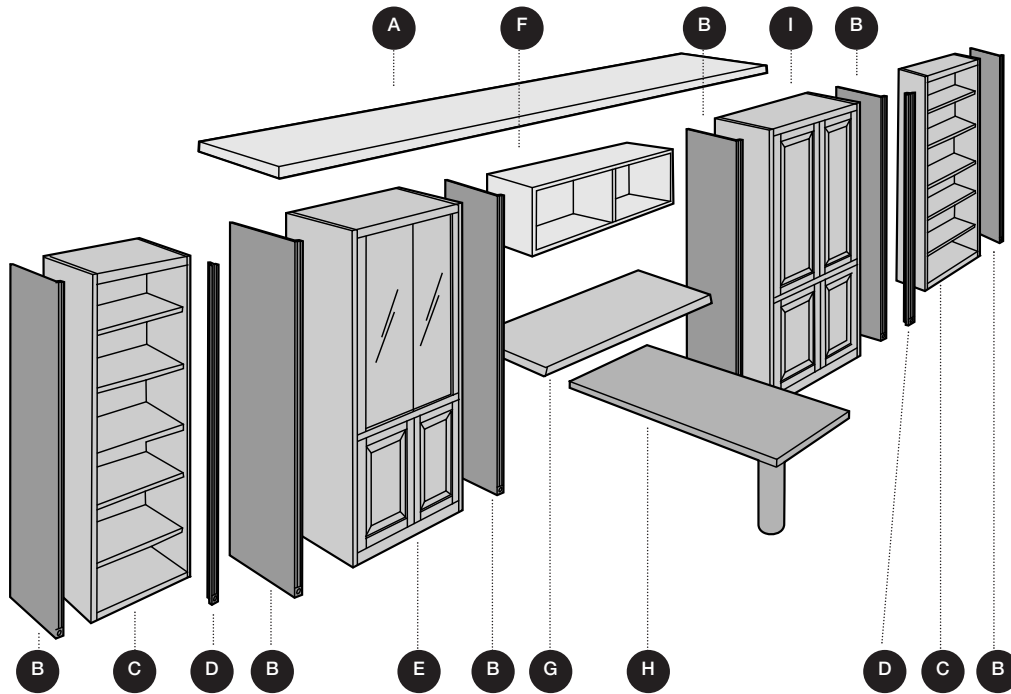

- A** Cornice
- B** End Panel
- C** Open Bookcase
- D** Mullion
- E** Open Bookcase with Optional Glass Doors above, and Optional Wood Doors below
- F** Open Cabinet
- G** Worksurface
- H** Runoff
- I** Open Bookcase with Optional Wood Doors above, and Optional Wood Doors below

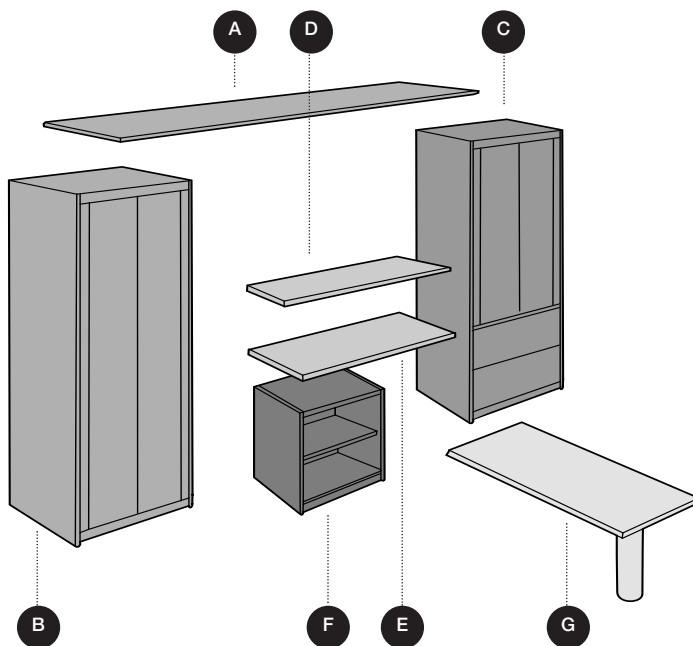

- A** Cornice
- B** Bookcase with Full Doors
- C** Bookcase with Lateral Files and Optional Wood Doors above
- D** Shelf
- E** Worksurface
- F** Open Bookcase
- G** Runoff

When optional doors are used, there is a fixed shelf 29" from the floor, or at a special height upon request.

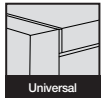

# Wall Unit Typical

## TYPE 1 AND TYPE 2

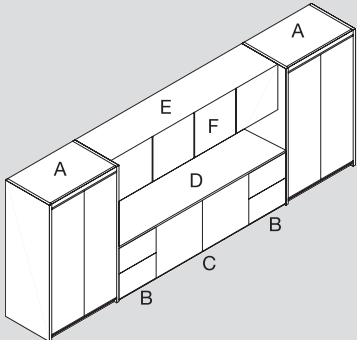
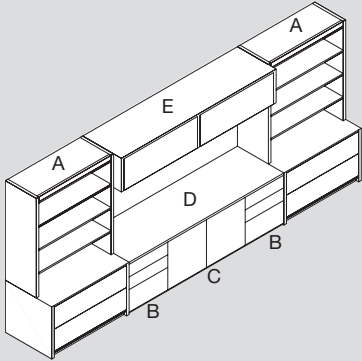
		Qty.	Style Number	List Price	Options
	<b>Type 1</b>	A.	2	GFD-8430	\$2054
	A. Bookcase with Full Wood Doors 84" H x 30" W x 18" D	B.	2	GUF-1818	971
		C.	1	GFD-2936	1393
		D.	1	GVT-7218	863
		E.	1	GCRTOP72	1026
		F.	2	GPHD-18	338
	B. Pedestal with File/File			TOTAL:	\$9037
	C. Bookcase with Full Wood Doors 29" H x 36" W x 18" D				
	D. Worksurface 72" W x 18" D				
	E. Overhead Open Storage Cabinet 72" W				
F. Hinged Wood Doors 36" W					
	<b>Type 2</b>	A.	2	GSPF-8436	\$2484
	A. Open Bookcase with Bottom Lat File 84" H x 36" W x 18" D	B.	2	GUB-1818	1011
		C.	1	GFD-2936	1393
		D.	1	GVT-7218	863
		E.	1	GCRTO72	1431
				TOTAL:	\$10677
	B. Pedestal with Box/Box/File				
	C. Bookcase with Full Wood Doors 29" H x 36" W x 18" D				
	D. Worksurface 72" W x 18" D				
	E. Overhead Storage with Flipper Door 72" W				



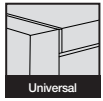

# Wall Unit Typical

## TYPE 5 AND TYPE 6

	Qty.	Style Number	List Price	Options
	<b>Type 5</b>			
	A.	2	GOP-8436	\$1371
	B.	1	GOPS-3660-G17	1664
	C.	1	GVT-6018	648
	D.	1	GCRTOP60	933
	E.	2	GCORE-84	<u>1960</u>
			TOTAL:	\$9907
	<b>Type 6</b>			
	A.	2	GSPD-843618	\$2187
	B.	2	GFD-2936	1393
	C.	1	GVT-7218	863
	D.	1	GCRTOP72	<u>1026</u>
			TOTAL:	\$7656

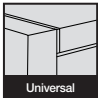

# Open Bookcase Units

VERTICAL

		Nominal width x depth	Ht.	Shelves	Style Number	Price	Wt.	Options		
<p><b>Open Bookcases</b></p> <p>Adjustable shelves.</p> <p>When optional doors are used, there is a fixed shelf 29" from the floor, or at a special height upon request.</p>		<p><b>30" wide</b> <b>12" deep</b></p>	29"	1	GOP-2930	\$728	35	<p><b>060</b> - 1.25" thick shelves 30/36" wide units + \$17. per shelf</p> <p><b>061</b> - Feature strips for ganging bookcases + \$60. each</p> <p><b>G13</b> - 15" deep unit + 20%</p> <p><b>G17</b> - 18" deep unit + 25%</p> <p><b>G22</b> - Finished outside back + 15%</p>		
			36"	2	GOP-3630	822	40			
			42"	2	GOP-4230	871	55			
			48"	3	GOP-4830	965	60			
			60"	3	GOP-6030	1013	75			
			72"	4	GOP-7230	1157	90			
			84"	5	GOP-8430	1342	105			
			96"	6	GOP-9630	1394	120			
		<p><b>36" wide</b> <b>12" deep</b></p>	29"	1	GOP-2936	\$757	45			
			36"	2	GOP-3636	852	50			
			42"	2	GOP-4236	900	65			
			48"	3	GOP-4836	995	70			
			60"	3	GOP-6036	1042	85			
			72"	4	GOP-7236	1186	100			
			84"	5	GOP-8436	1371	115			
			96"	6	GOP-9636	1424	130			
		<p><b>48" wide</b> <b>12" deep</b></p>	72"	8	GOP-7248	\$1639	110			
			84"	10	GOP-8448	1769	125			
			96"	12	GOP-9648	1862	140			
<b>Specifications</b>					.75" Construction Veneered edges 1" thick adjust. shelves					
<b>Actual widths</b>					30", 36", 48" wide					

# Open Bookcases

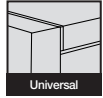

SPECIAL WIDTH BOOKCASES & BOOKCASES WITH GLASS DOORS

		Nominal width x depth	Ht.	Shelves	Style Number	Price	Wt.	Options			
<p><b>Special Width Open Bookcases</b></p> <p>Adjustable shelves.</p> <p>When optional doors are used there is a fixed shelf 29" above floor, or at a special height upon request.</p>		<p><b>42" wide 12" deep</b></p>	29"	2	GOPS-2942	\$926	60	<p><b>061</b> - Feature strips for ganging bookcases + \$66. each</p> <p><b>G13</b> - 15" deep unit + 20%</p> <p><b>G17</b> - 18" deep unit + 25%</p> <p><b>G22</b> - Finished outside back + 15%</p> <p><b>For Door Options see page 27.</b></p> <p>Note: units over 48" W require two sets doors.</p>			
			36"	4	GOPS-3642	1063	65				
			42"	4	GOPS-4242	1181	70				
			48"	6	GOPS-4842	1340	75				
			60"	6	GOPS-6042	1471	80				
		<p><b>48" wide 12" deep</b></p>	29"	2	GOPS-2948	\$1116	65				
			36"	4	GOPS-3648	1224	70				
			42"	4	GOPS-4248	1329	75				
			48"	6	GOPS-4848	1520	80				
			60"	6	GOPS-6048	1651	95				
		<p><b>60" wide 12" deep</b></p>	29"	2	GOPS-2960	\$1152	80				
			36"	4	GOPS-3660	1331	85				
			42"	4	GOPS-4260	1424	90				
			48"	6	GOPS-4860	1574	95				
			60"	6	GOPS-6060	1690	100				
<p><b>72" wide 12" deep</b></p>		29"	2	GOPS-2972	1380	100					
		36"	4	GOPS-3672	1597	105					
		42"	4	GOPS-4272	1658	110					
		48"	6	GOPS-4872	1728	115					
		60"	6	GOPS-6072	1860	120					
<p><b>Bookcases with Sliding Glass Doors</b></p> <p>Units 29" to 60" high have one set of sliding glass doors.</p> <p>Units over 60" high have two sets of sliding glass doors.</p>		<p><b>30" wide 12" deep</b></p>	29"	1	GGD-2930	\$1233	70	<p><b>061</b> - Feature strips for ganging bookcases + \$66. each</p> <p><b>G13</b> - 15" deep unit + 20%</p> <p><b>G17</b> - 18" deep unit + 25%</p> <p><b>G22</b> - Finished outside back + 15%</p> <p><b>G54</b> - Lock for sliding glass doors + \$65.</p> <p><b>For Cornices and Cornices with lights see page 25.</b></p>			
			36"	2	GGD-3630	1361	80				
			42"	2	GGD-4230	1441	90				
			48"	3	GGD-4830	1601	100				
			60"	3	GGD-6030	1740	110				
			72"	4	GGD-7230	2233	120				
		<p><b>36" wide 12" deep</b></p>	29"	1	GGD-2936	\$1262	75				
			36"	2	GGD-3636	1391	85				
			42"	2	GGD-4236	1470	95				
			48"	3	GGD-4836	1631	105				
			60"	3	GGD-6036	1769	115				
			72"	4	GGD-7236	2262	125				
			84"	5	GGD-8436	2512	135				
			<b>Specifications</b>						.75" Construction Veneered edges 1" thick adjust. shelves		
			<b>Actual widths</b>						30", 36", 42", 48", 59.25" W		



# Bookcases with Doors

## FULL WOOD DOOR UNITS

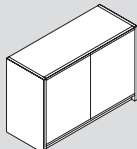
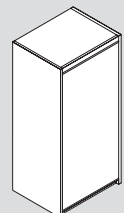
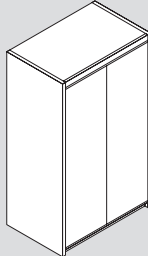
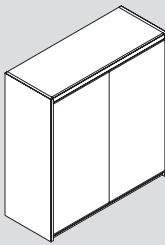
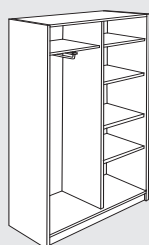
	Nominal width x depth	Ht.	Shelves	Style Number	Price	Wt.	Options
<b>Bookcases with Full Wood Doors</b>  Inside clearance: 10.75" on 12"D 16.75" on 18"D  FD units have adj. shelves. For closets with hat shelf and clothes carrier, specify FDW.		30" wide	29"	1	GFD-29302	\$1084	50
		12" deep	36"	2	GFD-36302	1179	60
		<b>24" wide Universal 18" D</b>  <b>Wardrobe/Closet</b> Single door	29"	1	GFD-2924	\$1213	80
			36"	2	GFD-3624	1329	90
			42"	2	GFD-4224	1361	100
			48"	3	GFD-4824	1527	110
	<b>30" wide Universal 18" D</b>  <b>Wardrobe/Closet</b> Double door	60"	3	GFD-6024	1622	120	
		72"	4	GFD-7224	1797	130	
		84"	5	GFD-8424	1912	140	
		<b>36" wide Universal 18" D</b>	29"	1	GFD-2930	\$1355	90
			36"	2	GFD-3630	1471	100
	42"		2	GFD-4230	1456	110	
	48"		3	GFD-4830	1669	120	
	60"		3	GFD-6030	1765	130	
		<b>48" wide Universal 18" D</b>  <b>Wardrobe/Closet</b> Double door w/ center partition	72"	4	GFD-7230	1940	140
			84"	5	GFD-8430	2054	150
29"			1	GFD-2936	1393	100	
36"			2	GFD-3636	1512	110	
42"			2	GFD-4236	1542	120	
	<b>Split Storage/Closet Option</b> (36 & 48" wide only) One side adj. shelves; One side pullout hanger and hat shelf. 60" high + \$308. 72" high + \$380. 84" high + \$427.	48"	3	GFD-4836	1708	130	
		60"	3	GFD-6036	1802	140	
		72"	4	GFD-7236	1999	150	
		84"	5	GFD-8436	2126	160	
<b>For Comices and Comices with lights</b> see page 25.		42"	4	GFD-4248	\$1928	130	
		48"	6	GFD-4848	2136	140	
		60"	6	GFD-6048	2246	150	
		72"	8	GFD-7248	2489	160	
		84"	10	GFD-8448	2658	170	
<b>Specifications</b>				.75" Construction Veneered edges 1" thick adjust. shelves			
<b>Actual widths</b>				30", 36", 48" wide			

# Bookcases

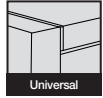

WITH BOTTOM DOOR SECTION

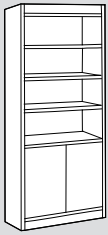
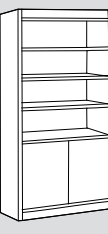
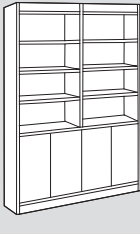
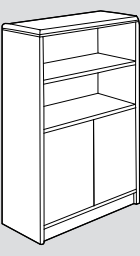
	Nominal width x depth	Ht.	Shelves	Style Number	Price	Wt.	Options	
<b>Open Bookcases with Bottom Door Section</b>  Hinged door section 29" high with one adjustable shelf.  Cabinet inside clearance: 10.75" deep.		30" wide	60"	2	GBD-6030	\$1369	90	
		12" deep	72"	3	GBD-7230	1513	105	
			84"	4	GBD-8430	1698	120	
			96"	5	GBD-9630	1751	135	
	36" wide 12" deep	60"	2	GBD-6036	\$1399	105		
		72"	3	GBD-7236	1543	120		
		84"	4	GBD-8436	1728	135		
		96"	5	GBD-9636	1780	150		
	48" wide 12" deep	72"	6	GBD-7248	\$2031	160		
		84"	8	GBD-8448	2162	180		
		96"	10	GBD-9648	2255	230		
	30" wide Universal 18"D	60"	2	GUBDS-6030	\$1711	100		
		72"	3	GUBDS-7230	1892	115		
		84"	4	GUBDS-8430	2124	130		
		96"	5	GUBDS-9630	2189	135		
	36" wide Universal 18"D	60"	2	GUBDS-6036	1750	115		
		72"	3	GUBDS-7236	1929	130		
		84"	4	GUBDS-8436	2161	145		
		96"	5	GUBDS-9636	2226	160		
		<b>Specifications</b>		.75" Construction Veneered edges 1" thick adjust. shelves				
		<b>Actual widths</b>		30", 36", 48" wide				
<b>Options</b> 010 - Door lock + \$66. per pair of doors 060 - 1.25" thick shelves 30/36" wide units + \$17 per shelf 061 - Feature strips for ganging bookcases + \$66. each G13 - 15" deep unit + 20% G17 - 18" deep unit + 25% G22 - Finished outside back + 15%								



# Bookcases

## WITH BOTTOM DOOR SECTION

		Nominal width x depth	Ht.	Shelves	Style Number	Price	Wt.	Options	
<p><b>Open Bookcases with Bottom Door Section</b></p> <p>Bookcase section 12" deep.</p> <p>Door section 15" or 18" deep, 29" high.</p> <p>Cabinet inside clearance: 13.75" on 15"D 16.75" on 18"D</p> <p>All units are shipped in two pieces.</p>		30" wide 15" deep	60"	2	GSPD-603015	\$1773	110	<p><b>010</b> - Door lock + \$66. per pair doors</p> <p><b>060</b> - 1.25" thick shelves 30/36" wide units + \$17. per shelf</p> <p><b>G22</b> - Finished outside back + 15%</p> <p><b>G24</b> - Feature strips for ganging + \$82. each</p>	
			72"	3	GSPD-723015	1895	125		
			84"	4	GSPD-843015	2018	140		
		96"	5	GSPD-963015	2154	155			
		30" wide 18" deep	60"	2	GSPD-603018	1868	115		
			72"	3	GSPD-723018	1995	130		
	84"		4	GSPD-843018	2124	145			
				96"	5	GSPD-963018	2227		160
		36" wide 15" deep	60"	2	GSPD-603615	\$1837	125		
			72"	3	GSPD-723615	1887	140		
			84"	4	GSPD-843615	2088	155		
			96"	5	GSPD-963615	2218	170		
36" wide 18" deep		60"	2	GSPD-603618	1857	130			
		72"	3	GSPD-723618	2060	145			
		84"	4	GSPD-843618	2187	160			
		96"	5	GSPD-963618	2251	175			
		48" wide 15" deep	60"	4	GSPD-604815	\$2248	160		
			72"	6	GSPD-724815	2414	180		
	84"		8	GSPD-844815	2578	200			
	96"		10	GSPD-964815	2744	220			
	48" wide 18" deep	60"	4	GSPD-604818	2395	165			
		72"	6	GSPD-724818	2592	185			
		84"	8	GSPD-844818	2842	205			
		96"	10	GSPD-964818	2901	225			
	<b>Specifications</b>					.75" Construction Veneered edges 1" thick adjust. shelves			
	<b>Actual widths</b>					30", 36", 48" wide			

# Bookcases

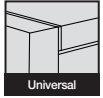

WITH BOTTOM LATERAL SECTION

		Nominal width x depth	Ht.	Shelves	Style Number	Price	Wt.	Options
<p><b>Open Bookcases with Bottom Lateral File Drawer Section</b></p> <p>Bookcase section 12" deep.</p> <p>Drawer section 18" deep, 29" high.</p> <p>Drawers are equipped with rods for lateral filing, legal or letter size.</p>		30" wide	60"	2	GSPF-6030	\$2165	146	<p><b>060</b> - 1.25" thick shelves 30/36" wide units + \$19. per shelf</p> <p><b>G24</b> - Feature strips for ganging bookcases + \$66. each</p> <p><b>G13</b> - 15" deep unit + 20%</p> <p><b>G22</b> - Finished outside back + 15%</p> <p><b>012</b> - Drawer lock + \$82. per pedestal</p>
			72"	3	GSPF-7230	2292	161	
			84"	4	GSPF-8430	2363	176	
			96"	5	GSPF-9630	2536	191	
		36" wide	60"	2	GSPF-6036	\$2185	161	
			72"	3	GSPF-7236	2357	176	
			84"	4	GSPF-8436	2484	191	
			96"	5	GSPF-9636	2598	206	
		48" wide	60"	4	GSPF-6048	\$2685	196	
			72"	6	GSPF-7248	2889	216	
			84"	8	GSPF-8448	3139	236	
			96"	10	GSPF-9648	3198	256	
<p><b>Open Bookcases with Bottom Lateral File Drawer Section</b></p> <p>Universal 18" deep.</p> <p>Drawer section 29" high.</p> <p>Drawers are equipped with rods for lateral filing, legal or letter size.</p>		30" wide	60"	1	GUBFS-6030	\$2374	145	
			72"	2	GUBFS-7230	2522	155	
			84"	3	GUBFS-8430	2663	165	
			96"	4	GUBFS-9630	2790	175	
		36" wide	60"	1	GUBFS-6036	\$2404	155	
			72"	2	GUBFS-7236	2592	165	
			84"	3	GUBFS-8436	2731	175	
			96"	4	GUBFS-9636	2803	185	
<b>Specifications</b>					.75" Construction Veneered edges 1" thick adjust. shelves			
<b>Actual widths</b>					30", 36", 48" wide			



# Video Cabinets

## AUDIO VISUAL

		Nominal width x depth	Ht.	Shelves	Style Number	Price	Wt.	Options	
<p><b>CRT/Video Cabinet</b></p> <p>TV monitor area in top.</p> <p>Retractable doors.</p> <p>Bottom has 1 fixed, 1 slide out &amp; 1 adjustable shelf.</p> <p>Inside dimensions top section: 60" H x 33.5" W 72" H x 45.5" W 84" H x 45.5" W</p>		30" wide 24" deep	60"	1	GCRTC-6030	\$3168	260	<p><b>010</b> - Door lock + \$66. per pair doors</p> <p><b>012</b> - Drawer lock + \$82. per pedestal</p>	
			72"	2	GCRTC-7230	3309	280		
			84"	2	GCRTC-8430	3488	300		
		36" wide 24" deep	60"	1	GCRTC-6036	3656	270		
			72"	2	GCRTC-7236	3789	290		
			84"	2	GCRTC-8436	3914	310		
		42" wide 30" deep	60"	1	GCRTC-6042	\$3657			
			72"	2	GCRTC-7242	3790			
			84"	2	GCRTC-8442	3915			
		<p><b>Storage Cabinet</b></p> <p>Hinged upper door section; lateral files lower section</p> <p>22.25" inside depth</p>	30" wide 24" deep	60"	1	GCRTF-6030	\$2720		260
				72"	2	GCRTF-7230	2967		280
				84"	3	GCRTF-8430	3087		300
	36" wide 24" deep	60"	1	GCRTF-6036	3282	270			
		72"	2	GCRTF-7236	3415	290			
		84"	3	GCRTF-8436	3593	310			
<p><b>Storage Cabinet</b></p> <p>Hinged door cabinets in both upper and lower sections.</p> <p>22.25" inside depth</p>		30" wide 24" deep	60"	1	GCRTS-6030	\$2535	260		
			72"	2	GCRTS-7230	2682	280		
			84"	4	GCRTS-8430	2858	300		
		36" wide 24" deep	60"	1	GCRTS-6036	2868	270		
			72"	2	GCRTS-7236	3001	290		
			84"	4	GCRTS-8436	3180	300		
	<b>Specifications</b>					.75" Construction Veneered edges 1" thick adjust. shelves			
	<b>Actual widths</b>					30", 36", 42" wide			

# Corner Units

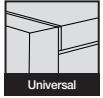

CORNER SHELVING

**Open Shelf  
Corner Units**

Adjustable shelves.

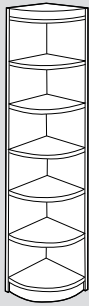

Sides to Wall

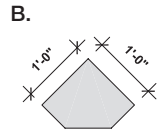
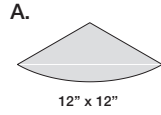

Ht.	Shelves	Style Number	Price	Wt.
60"	3	GCORE-60	\$1603	80
72"	4	GCORE-72	1782	85
84"	5	GCORE-84	1960	90
96"	6	GCORE-96	2138	95

Specify A or B shelf suffix

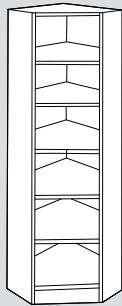

24" x 24"

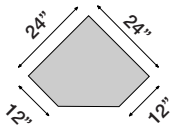

60"	3	GCORS-60	\$1984	160
72"	4	GCORS-72	2162	170
84"	5	GCORS-84	2340	180
96"	6	GCORS-96	2530	190

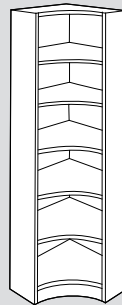

24" x 24"

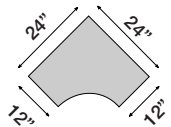

60"	3	GCORC-60	\$2103	160
72"	4	GCORC-72	2292	170
84"	5	GCORC-84	2479	180
96"	6	GCORC-96	2673	190



**Specifications**

.75" Construction  
Veneered edges  
1" thick adjust. shelves

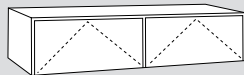

# Overhead Cabinets & Runoffs

## CABINETS, RUNOFFS AND ACCESSORIES

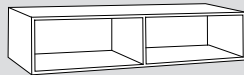
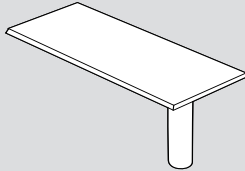
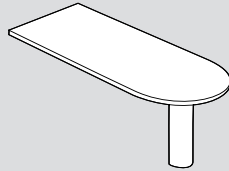
		Width x Depth	Ht.	Universal Style Number	List Price	Options		
	<b>Overhead Storage Cabinet with Flipper Door</b>	30 x 15"	16"	GCRT030	\$919	<b>011</b> - Door lock + \$66. per door  <b>070</b> - Tasklight w/ facia + \$309.		
		36 x 15"	16"	GCRT036	1011			
	<b>Overhead Storage Cabinet with Flipper Door</b>	60 x 15"	16"	GCRT060	\$1301			
		72 x 15"	16"	GCRT072	1431			
	<b>Overhead Open Storage Cabinet</b>	30 x 15"	18"	GCRTOP30	\$597		<b>070</b> - Tasklight w/ facia + \$309.	
		36 x 15"	18"	GCRTOP36	657			
	<b>Overhead Open Storage Cabinet</b>	60 x 15"	18"	GCRTOP60	\$933			
		72 x 15"	18"	GCRTOP72	1026			
	<b>Runoff with Cylinder Base</b> 3" diameter leg Silver or Black	48 x 28"	29"	GCRTS-4828	\$1238			<b>020</b> - Center drawer + \$184. <b>031</b> - Articulating keyb'd arm + \$458. <b>033</b> - Grommet + \$55.
		60 x 28"	29"	GCRTS-6028	1458			
	<b>Bullet Runoff with Half-Cylinder Base</b> 3" diameter leg Silver or Black	48 x 28"	29"	GCRTB-4828	\$1408			
		60 x 28"	29"	GCRTB-6028	1639			

# Component Cabinets

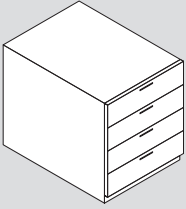
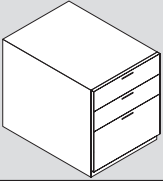
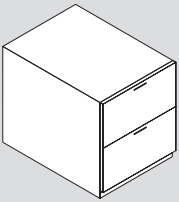
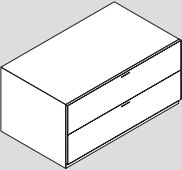
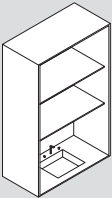
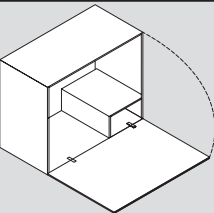
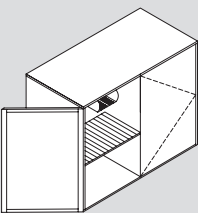

## PEDESTALS, BARS AND REFRIGERATOR

		Width x Depth	Ht.	Universal Style Number	List Price	Ship Wt.	Options
	<b>Pedestal with 4 Box Drawers</b>	18 x 18"		GUBB-1818	\$1061	85	<b>012</b> - Pedestal lock + \$86. per pedestal.
	<b>Pedestal with Box/Box/File</b>	18 x 18"		GUB-1818	\$1011	85	
	<b>Pedestal with File/File</b>	18 x 18"		GUF-1818	\$971	85	
	<b>Pedestal with 2 Lateral Files</b>	30 x 18"		GULF-3018	\$1212	110	
		36 x 18"		GULF-3618	1303	120	
	<b>Wet Bar Unit</b> <ul style="list-style-type: none"> <li>Laminated countertop and glass shelves</li> <li>Sink by others</li> </ul>	Size of cabinet depends on size of sink. Call factory for a custom quote. Information needed: Size & model number of sink, cabinet style with overall desired size of cabinet.					
	<b>Dry Bar Unit</b> <ul style="list-style-type: none"> <li>Partial shelf and flap</li> <li>Laminate interiors</li> </ul>	36 x 18"	24"	GDBAR-3618	\$1745	80	
	<b>Built-In Refrigerator</b>	36 x 18"		GFRIG-3618	\$2914	200	*Refrigerator can be added to any cabinet with doors by adding \$1323 to cabinet cost.
		36 x 24"		GFRIG-3624	3073	220	



# Components for Universal

## CORNICE TOPS, MULLIONS, END, SIDE AND BACK PANELS

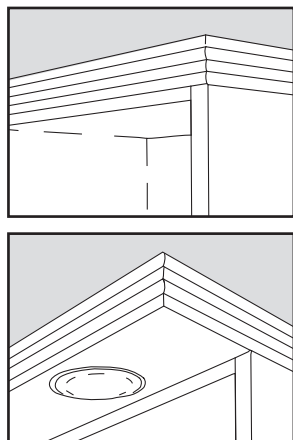

### Cornices for Universal Bookcases

**Without lights:**

12.5" deep; .5" overhang in front \$115. per linear foot  
 18.5" deep; .5" overhang in front \$132. per linear foot

**With lights:**

16" deep; 4" overhang in front \$127. per linear foot for cornice  
 22" deep; 4" overhang in front \$138. per linear foot for cornice  
 and  
 + \$525. per set of 2 Halogen lights.  
 + \$665. per set of 3 Halogen lights.  
 + \$820. per set of 6 Halogen lights  
 Each set includes a low voltage switch.

For Universal  
 Cornices only  
 Specify Edge Detail:  
 B, D, E, L, or M

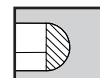

B - 2" Bullnose

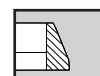

D - 2" Bevel

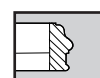

E - 2" Traditional

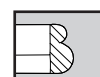

L - 2" Duet

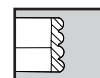



M - 2" Reeded

MULLIONS AND END PANELS		Style Number	Width x Depth	Ht.	List Price	Ship Wt.	Options
<p>Mullion   Plain End   Raised End</p>	<p><b>Mullion</b>                      Specify: A or B after style number</p>	GPM4812-__	2" wide	48"	\$125	5	<p>G17 - 18" wide panels + 25%                      G01 - 24" wide panels + 30%</p> <p>Each mullion adds .75" to the width of a run.                      Each end panel adds 1.5" to the width of a run.</p>
		GPM6012-__	2"	60"	137	8	
		GPM7212-__	2"	72"	143	12	
		GPM8412-__	2"	84"	166	15	
		GPM9612-__	2"	96"	202	18	
	<p><b>Plain End Panels with Facia</b>                      Specify: A or B after style number, left or right side.</p>	GPP4812-__	2" x 12.5"	48"	\$213	30	
		GPP6012-__	2" x 12.5"	60"	238	35	
		GPP7212-__	2" x 12.5"	72"	262	40	
		GPP8412-__	2" x 12.5"	84"	297	45	
		GPP9612-__	2" x 12.5"	96"	327	50	
<p><b>Raised Panel End Panels with Facia</b>                      Specify: A or B after style number, left or right side.</p>	GPR4812-__	2" x 12.5"	48"	\$488	30		
	GPR6012-__	2" x 12.5"	60"	522	35		
	GPR7212-__	2" x 12.5"	72"	559	40		
	GPR8412-__	2" x 12.5"	84"	594	45		
	GPR9612-__	2" x 12.5"	96"	630	50		
<p>A - Traditional   B - Reeded</p>							
<p><b>Side and Back Panels</b>                      .75" thick</p>		Width x Depth	Ht.	Universal Style No.	List Price	Ship Wt.	Options
		24"	60"	GCRTSP-6024	\$399	25	<p>033 - Grommet + \$55.</p>
		24"	72"	GCRTSP-7224	451	30	
		30"	60"	GCRTBP-6030	659	30	
		30"	72"	GCRTBP-7230	797	35	
		30"	84"	GCRTBP-8430	909	35	
		60"	60"	GCRTBP-6030	886	60	
		60"	72"	GCRTBP-7230	522	65	
	60"	84"	GCRTBP-8430	1200	75		

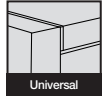
# Components for Universal

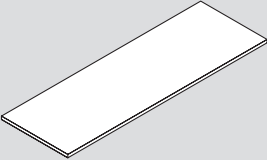
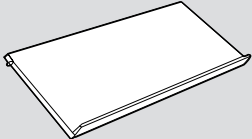

## SHELVES & WORKSURFACES

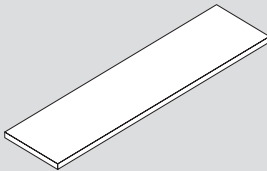
		Width x Depth	Universal Style Number	List Price	Ship Wt.	Options	
 <p><b>Shelves</b> for Universal Bookcases</p> <ul style="list-style-type: none"> <li>• 1" thick</li> </ul>		28.5 x 12"	GCR TT-3012	\$77	10		
		28.5 x 18"	GCR TT-3018	85	15		
		28.5 x 24"	GCR TT-3024	102	20		
		34.5 x 12"	GCR TT-3612	81	20		
		34.5 x 18"	GCR TT-3618	89	30		
		34.5 x 24"	GCR TT-3624	107	40		
 <p><b>Periodical Shelf</b></p> <ul style="list-style-type: none"> <li>• Lip 1.5"</li> </ul>		28.5" wide	GLPS-30	\$119	12		
		34.5" wide	GLPS-36	133	15		
 <p><b>Glass Shelf</b></p> <ul style="list-style-type: none"> <li>• 1/4" thick clear glass</li> <li>• 12" deep</li> </ul>		28.5" wide	GLGS-30	\$72	12		
		34.50" wide	GLGS-36	79	15		
 <p><b>Worksurfaces</b></p> <ul style="list-style-type: none"> <li>• Tops are 1 1/4" thick with veneer edge</li> </ul> <p><i>To find cost of a custom length top, go to the next larger size.</i></p>		36 x 18"	GVT-3618-__	\$501		<b>020</b> - Center drawer + \$284. <b>032</b> - Mini keyboard arm + \$364. <b>033</b> - Grommet + \$44.	
		48 x 18"	GVT-4818-__	573			
		60 x 18"	GVT-6018-__	648			
		72 x 18"	GVT-7218-__	863			
		84 x 18"	GVT-8418-__	1076			
		96 x 18"	GVT-9618-__	1292			
		120 x 18"	GVT-12018-__	1575			
		144 x 18"	GVT-14418-__	1877			
		36 x 24"	GVT-3624-__	551			
		48 x 24"	GVT-4824-__	633			
		60 x 24"	GVT-6024-__	710			
		72 x 24"	GVT-7224-__	939			
		84 x 24"	GVT-8424-__	1184			
		96 x 24"	GVT-9624-__	1428			
		120 x 24"	GVT-12024-__	1742			
		144 x 24"	GVT-14424-__	2102			



# Bookcase Accessories

## GLASS AND WOOD DOORS

			Style Number	Bookcase Height	List Price	Ship Wt.	Options
<p><b>Glass Doors for Shelving</b></p> <p>.25" thick clear glass</p> <p>Prices are per pair, for 30" and 36" wide units only.</p> <p>Units wider than 36" require two sets of doors.</p>		<p><b>Sliding Glass Doors</b></p>	GGSD-18	18"	\$479	25	<p><b>G54</b> - Sliding glass door lock + \$65.</p>
			GGSD-29	29"	504	30	
			GGSD-36	36"	537	35	
			GGSD-42	42"	569	40	
			GGSD-48	48"	635	45	
			GGSD-60	60"	727	50	
			GGSD-72	72"	1075	70	
			GGSD-84	84"	1140	80	
			GGSD-96	96"	1271	90	
					<p><b>Hinged Metal Frame Glass Doors</b></p>	GMDHD-18	
GMDHD-29	29"	513				25	
GMDHD-36	36"	525				30	
GMDHD-42	42"	575				35	
GMDHD-48	48"	622				40	
GMDHD-60	60"	678				45	
GMDHD-72	72"	737				60	
GMDHD-84	84"	905				70	
GMDHD-96	96"	970				80	
		<p><b>Hinged Glass Doors</b></p> <ul style="list-style-type: none"> <li>With 2.25" solid wood frame on four sides.</li> </ul>				GGFFD-18	18"
			GGFFD-29	29"	700	30	
			GGFFD-36	36"	748	35	
			GGFFD-42	42"	796	40	
			GGFFD-48	48"	985	45	
			GGFFD-60	60"	1045	50	
			GGFFD-72	72"	1104	70	
			GGFFD-84	84"	1591	80	
			GGFFD-96	96"	1663	90	
			<p><b>Wood Doors for Shelving</b></p> <p>Prices are per pair, for 30" and 36" wide units only.</p> <p>Units wider than 36" require two sets of doors.</p>		<p><b>Hinged Straight Grain Wood Doors</b></p> <ul style="list-style-type: none"> <li>.75" thick</li> </ul>	GPHD-18	18"
GPHD-29	29"	356				30	
GPHD-36	36"	386				35	
GPHD-42	42"	415				40	
GPHD-48	48"	463				45	
GPHD-60	60"	499				50	
GPHD-72	72"	558				70	
GPHD-84	84"	618				80	
GPHD-96	96"	688				90	
		<p><b>Hinged Raised Panel Wood Doors</b></p> <ul style="list-style-type: none"> <li>Square frame; solid wood raised panel insert.</li> </ul>				GRPD-18	18"
			GRPD-29	29"	534	30	
			GRPD-36	36"	588	35	
			GRPD-42	42"	653	40	
			GRPD-48	48"	843	45	
			GRPD-60	60"	903	50	
			GRPD-72	72"	974	70	
			GRPD-84	84"	1304	80	
			GRPD-96	96"	1425	90	

- Glass doors and raised panel doors 48", 60" and 72" high have a center wood rail.
- Shelving 72" high and over have two sets of doors.
- Units wider than 36" require two sets of doors.

# Wall-Hung Shelves



KV SHELVING

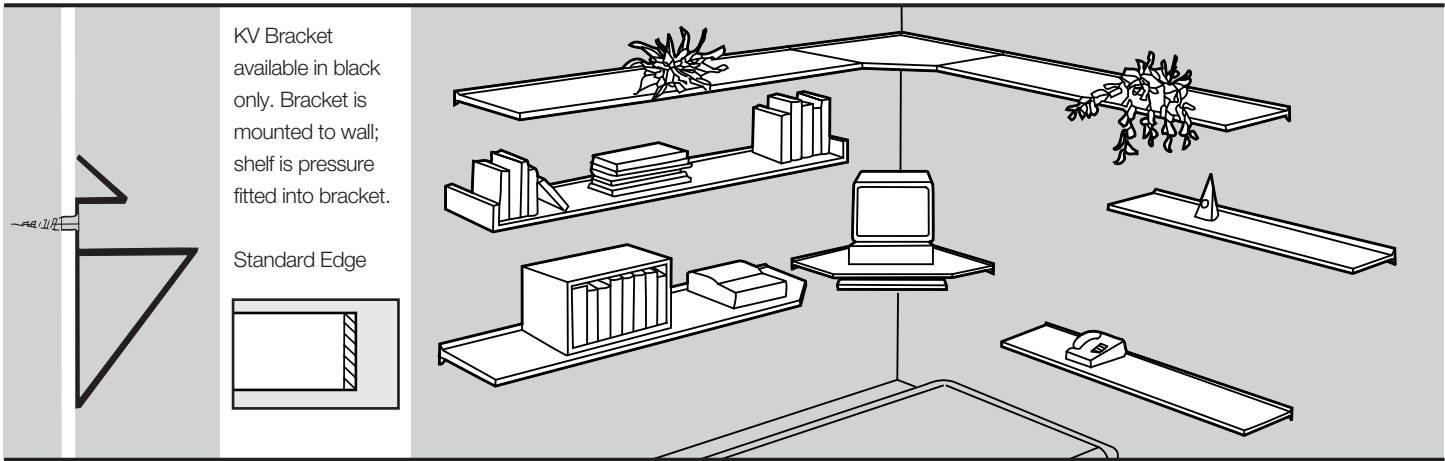

KV Bracket available in black only. Bracket is mounted to wall; shelf is pressure fitted into bracket.

Standard Edge

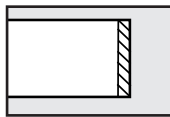

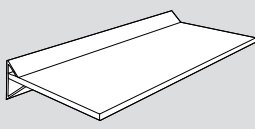
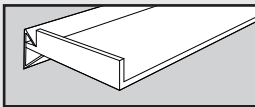
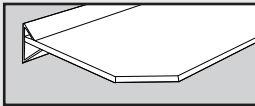
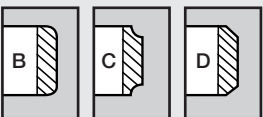
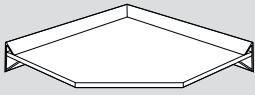



			Style Number	Shelf Depth	List Price	Ship Wt	Options
 <p><b>Wall-Hung Shelf with KV bracket</b> 12" or 15" deep. Shelf .75" thick</p> <p>Generally KV Shelves will support the following weights:</p> <ul style="list-style-type: none"> <li>40 lbs. per ft. – brick or concrete wall</li> <li>33 lbs. per ft. – concrete block wall</li> <li>25 lbs. per ft. – into stud of 1/2" wallboard</li> <li>15 lbs. per ft. – 1/2" wallboard</li> </ul>	36" wide	GKVSH-36 GKVSH-361	12" 15"	\$154 191	15 17	<p><b>G33</b> - 4" high Book Ends of Shelf \$81. per end</p>  <p><b>G34</b> - 45° cutoff on end of 15" shelf to mate with 12" ends \$76. per end</p>  <p><b>Optional Edge details:</b> + 25%</p>  <p><b>030</b> - Keyboard Drawer (Corner units only) + \$310.</p>	
	48" wide	GKVSH-48 GKVSH-481	12" 15"	184 233	20 23		
	60" wide	GKVSH-60 GKVSH-601	12" 15"	219 268	25 30		
	72" wide	GKVSH-72 GKVSH-721	12" 15"	268 315	30 38		
	84" wide	GKVSH-84 GKVSH-841	12" 15"	303 351	35 45		
	96" wide	GKVSH-96 GKVSH-961	12" 15"	327 362	40 50		
	 <p><b>Wall-Hung Corner with KV bracket</b> 24 x 24" with 17" front edge or 30 x 30" with 21" front edge. Mating edge on each side: 12". Shelf .75" thick</p> <p><i>Note – Wall must be square.</i></p>	24" wide	GKVSH2424	24"	\$446		40
		30" wide	GKVSH3030	30"	505		60

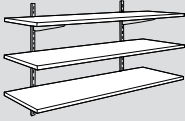

# Standard Wall-Hung Shelves

## KV SHELVING

			Style Number	OA Height	List Price	Ship Weight
 <p><b>Wall-Hung Shelves</b> 12" deep</p> <p>Shelves, standards, and brackets are ordered separately.</p>	<b>36" wide</b>	GSH-36	.75"	\$80	12	
		GSH-361	1.25"	90	18	
	<b>48" wide</b>	GSH-48	.75"	107	16	
		GSH-481	1.25"	118	24	
	<b>60" wide</b>	GSH-60	.75"	135	20	
		GSH-601	1.25"	149	30	
	<b>72" wide</b>	GSH-72	.75"	161	24	
		GSH-721	1.25"	178	36	
	<b>84" wide</b>	GSH-84	.75"	189	28	
		GSH-841	1.25"	198	42	
	<b>96" wide</b>	GSH-96	.75"	213	32	
		GSH-961	1.25"	235	48	
	 <p><b>Standards for Wall-Hung Shelves</b></p> <p>Standards are available in black or Anachrome. Please specify.</p>		GST-36	36"	\$19	10
			GST-48	48"	20	11
		GST-60	60"	24	12	
		GST-72	72"	27	13	
		GST-84	84"	29	14	
		GST-96	96"	35	15	
 <p><b>Standards Mounted in Wood for Wall-Hung Shelves</b></p> <p>Standards are available in black or Anachrome. Please specify.</p>		GSTW-36	36"	\$94	15	
		GSTW-48	48"	117	16	
		GSTW-60	60"	143	17	
		GSTW-72	72"	168	18	
		GSTW-84	84"	193	19	
		GSTW-96	96"	218	20	
 <p><b>Support Brackets for 12" Shelves</b></p> <p>Brackets are available in black or Anachrome. Please specify.</p>		GB-12		\$21	5	

# Options

## Locks

- 010 - Door lock + \$66 for each pair of doors.

---

- 011 - Door lock + \$66 for each individual door.

---

- 012 - Drawer lock + \$86 per pedestal.

---

- 013 - Center drawer lock + \$40.  
Lock for center drawer on desks.

## Drawers and Pedestals

- 020 - Center drawer for desk + \$184.00  
22" wide.

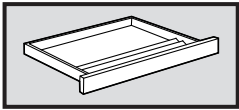

- 021 - File/file pedestal instead of B/B/F.  
No additional charge.

- 022 - Horizontal wood finger pulls + \$78  
per drawer.

- 030 - Pull-out keyboard drawer + \$342.  
Inside dimensions: 22"W x 12"D x 2"H.  
Available for conference tables, desk  
height returns (48" or longer), writing  
credenzas, and storage units.

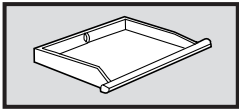

## Computer & Electrical Equipment

- 033 - 2" diameter grommet  
with cap. *Please order  
by complete model  
number below. If no  
model number is given  
#033-A will be supplied.*

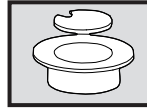

033-A*	Black Plastic	+ \$55.
033-B	Matte Black Metal	+ \$110.
033-C	Polished Chrome	+ \$110.
033-D	Satin Chrome	+ \$110.
033-E	Polished Brass	+ \$120.
033-F	Antique Brass	+ \$120.
033-G	Satin Nickel	+ \$120.

\*Due to slight variances in grommet hole size, a plastic grommet cannot be swapped for a metal grommet after the hole has been cut and vice-versa.

- 036 - Plastic cable raceway + \$8 per linear foot  
1.5 x 1". Ideal for managing computer  
and electric wires. Can be attached to  
any surface with double-faced tape.

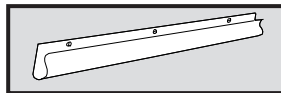

**For additional power/data options, please refer to the Arnold Kolax Furniture Power & Data Options Price Guide.**

# Dock Delivery Price List

## For Arnold Kolax Furniture

ORDERS OVER \$25,000 LIST CALL THE FACTORY

### ZONE ONE

NORTHERN NEW JERSEY,  
MANHATTAN, BRONX, QUEENS,  
STATEN ISLAND & BROOKLYN

**3.5% OF FURNITURE LIST PRICE  
IS THE NET FREIGHT COST**  
MINIMUM \$125

### ZONE TWO

FAIRFIELD, CT.  
WESTCHESTER, ROCKLAND,  
NASSAU COUNTIES, NY,  
SUFFOLK COUNTY,  
SOUTHERN NEW JERSEY

**4% OF FURNITURE LIST PRICE  
IS THE NET FREIGHT COST**  
MINIMUM \$175

### ZONE THREE

NEW HAVEN, HARTFORD, CT,  
PHILADELPHIA & PA EAST OF HARRISBURG

**5% OF FURNITURE LIST PRICE  
IS THE NET FREIGHT COST**  
MINIMUM \$190

### ZONE FOUR

RHODE ISLAND,  
PA WEST OF HARRISBURG,  
UPSTATE NEW YORK, DELAWARE, MARYLAND  
WASHINGTON DC, BOSTON &  
MASSACHUSETTS

**5.5% OF FURNITURE LIST PRICE  
IS THE NET FREIGHT COST**  
MINIMUM \$225

### FOR DESTINATIONS NOT SHOWN OR FOR INSIDE DELIVERY AND INSTALLATIONS PLEASE CALL FACTORY

Prices shown above represent non-union, straight time delivery.

Crating charges are included in the price.

Product may arrive blanket wrapped or crated.

It is the customers responsibility to make sure that furniture can fit in building and elevator.

Allow 6-8 days additional to acknowledged shipping date for delivery.

Upcharges will be assessed for the following:

- overtime delivery
- union requirements
- carry-up of furniture
- moving of existing furniture
- attempted delivery
- masonite coverage on floors
- disassembly of furniture for narrow doorways or elevators
- special insurance requirements
- over-sized desk (wider than 96")

*Due to the uncertainty of energy prices a fuel surcharge may be applicable. Please check our web site for up to date freight information.*





**Phone 973-375-3344**  
**Toll Free 866-425-6529**  
**Fax 973-375-6024**  
**[arnoldkolax.com](http://arnoldkolax.com)**

**arnoldkolax**

Arnold Kolax Furniture, Inc.

Arnold Kolax Furniture, Inc.  
609 Chancellor Avenue • Irvington, NJ 07111