

Modular Components

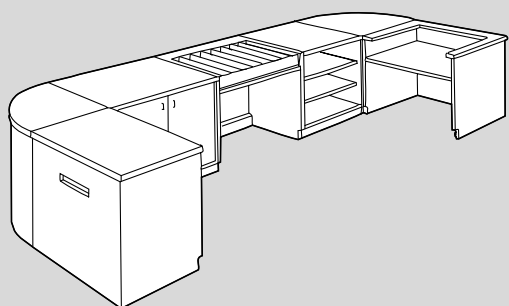

Arnold Kolax Circulation Desk Units are modular in design for the maximum in flexibility of arrangement. Units can be combined in virtually any configuration. When ordering please submit a plan of the arrangement intended. This will assist us in matching grain patterns on tops and fronts of units, which we will attempt to do as much as possible.

Please Note: Pacific/Mountain = 40% Upcharge
 Canyon = 50% Upcharge
 Ridge = 70% Upcharge

*Custom solutions are available. Please consult with factory.

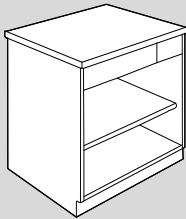
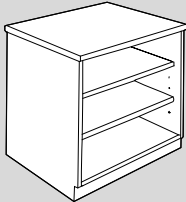
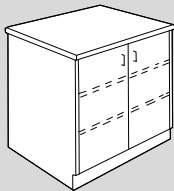
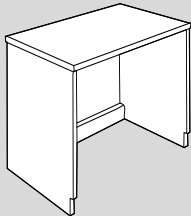
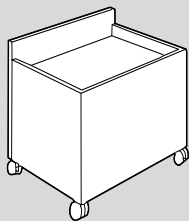
		Width x Depth	Ht.	Style Number	List Price	Ship Wt.	Options
	Charge Drawer Unit Inside depth: 24" 1 card file drawer, 1 box drawer, and 1 adjustable shelf.	36 x 27"	36"	GLCDU-36-__	\$2,598	200	
		36 x 27"	39"	GLCDU-39-__	2,610	210	
	Open Shelf Unit Inside depth: 24" 2 adjustable shelves.	36 x 27"	36"	GLOP-36-__	1,660	220	
		36 x 27"	39"	GLOP-39-__	2,022	230	
	Hinged Door Storage Unit Inside depth: 24" 2 adjustable shelves.	36 x 27"	36"	GLFD-36-__	1,898	245	Optional: Door lock + \$55. per pair of doors.
		36 x 27"	39"	GLFD-39-__	1,993	255	
	Book Return Unit Book slot on approach side. • 3" x 16" slot	36 x 27"	36"	GLBR-36-__	1,338	170	
		36 x 27"	39"	GLBR-39-__	1,350	180	
	Depressible Book Return Unit High pressure laminate depressible platform. Casters.	33 x 25"	36"	GLBRC-36-__	1,731	127	
		33 x 25"	39"	GLBRC-39-__	1,787	137	

Modular Components

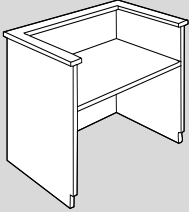
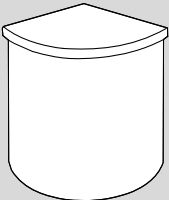
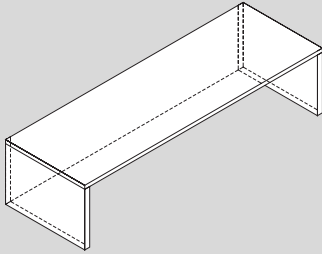
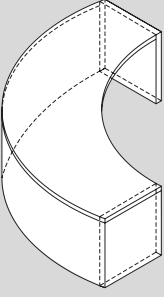
		Width x Depth	Ht.	Style Number	List Price	Ship Wt.
	Typing Desk Unit	36 x 27"	36"	GLTU-36-__	\$1,695	190
		36 x 27"	39"	GLTU-39-__	1,799	200
	Corner Unit Forms a 90° rounded corner.	27 x 27"	36"	GLCU-36-__	1,399	117
		27 x 27"	39"	GLCU-39-__	1,413	127
	Transaction Counter Rectangular	36 x 10"	12"	GLTCR-36	755	
	Transaction Counter Curved	27 x 10"	12"	GLTCR-27	1,075	

Circulation Desk Accessories

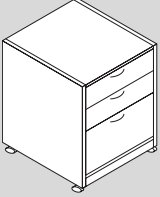
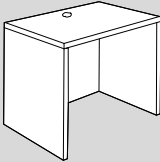
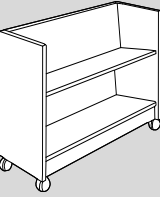
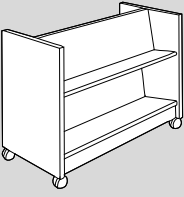
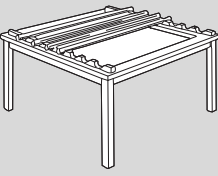
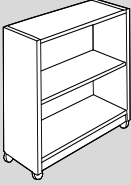
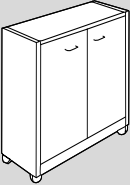
		Width x Depth	Ht.	Style Number	List Price	Ship Wt.	Options
	Mobile Unit 3 drawers. Casters.	16.75x18"	28"	GLMF-__	\$1,233	100	012 - Drawer lock + \$78 per pedestal.
	Computer Utility Table Grommet. No casters.	30 x 30" 36 x 30" 42 x 30" 54 x 30" 60 x 30" 72 x 30"	29" 29" 29" 29" 29" 29"	GLCU-30 GLCU-36 GLCU-42 GLCU-54 GLCU-60 GLCU-72	879 1,050 1,350 1,750 2,350 2,550	85 85 85 85 85 85	030 - Keyboard drawer + \$284
	Book Return Cart Single Sided Casters.	36 x 14"	28"	GLFBR-__	1,159	95	
	Book Return Cart Double Sided Casters.	36 x 18"	28"	GLFDBR-__	1,324	110	
	Newspaper Rack 10 wooden display rods.	40 x 26"	29"	GLNR-26-__	1,399	92	
	Mobile Open Bookcase 18" deep 1 adjustable shelf. Casters.	30"w	28"	GLMB-__	899	85	
	Mobile Storage Unit 18" deep Casters.	30"w	28"	GLMS-__	1,057	92	010 - Door Lock + \$55 per pair doors.

Circulation Desk Accessories

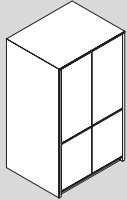
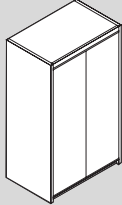
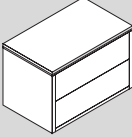
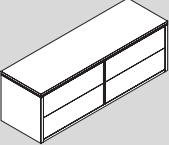
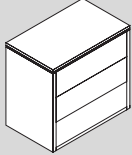
		Width	Ht.	Shelves	Style Number	List Price	Ship Wt.	Options	
	Audio/Video Cabinet 24" deep	30" W	60"		GLCRTC-6030	\$3,700			
			72"		GLCRTC-7230	4,000			
			84"		GLCRTC-8430	4,500			
	<ul style="list-style-type: none"> • Pull-out shelf and retractable doors in upper section. • Pull-out shelf in lower section. 	36" W	60"		GLCRTC-6036	3,775			
			72"		GLCRTC-7236	4,100			
			84"		GLCRTC-8436	4,625			
		Storage Cabinet	30" W	29"	1	GLWD-2930	1,250		
				60"	3	GLWD-6030	1,800		
	19" deep	72"	4	GLWD-7230	1,925				
		84"	5	GLWD-8430	2,100				
		36" W	29"	1	GLWD-2936	1,375			
			60"	3	GLWD-6036	1,925			
	<ul style="list-style-type: none"> • Cabinet with full wood doors. 	72"	4	GLWD-7236	2,075				
		84"	5	GLWD-8436	2,250				
	File Credenza	30" W	29"		GLFC-30	600			
	19" deep	36" W	29"		GLFC-36	700			
<ul style="list-style-type: none"> • 2 lateral file drawers. 									
	File Credenza	60" W	29"		GLFC-60	1,200			
	19" deep	72" W	29"		GLFC-72	1,350			
	File Credenza	30" W	29"		GLFCH-30	900			
	19" deep	36" W	29"		GLFCH-36	1,050			
<ul style="list-style-type: none"> • 3 lateral file drawers. 									

Phone 973-375-3344
Toll Free 866-425-6529
Fax 973-375-6024
arnoldkolax.com

arnoldkolax

Arnold Kolax Furniture, Inc.

Arnold Kolax Furniture, Inc.
609 Chancellor Avenue • Irvington, NJ 07111